



PROFILATI A FREDDO

BINARIO GUIDA

MONOROTAIE

ANGOLO

“ELLE”

“U”

OMEGA

“C”

BINARIO GUIDA

RICAVATO DA NASTRO ZINCATO A CALDO SPESSORE 4 mm. - PESO Kg/ml 3,70

SEZIONE A : A
BINARIO

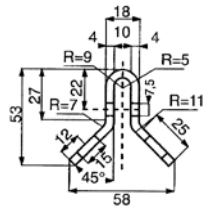

SOLUZIONE
CON BINARIO
INCASSATO NEL
PAVIMENTO

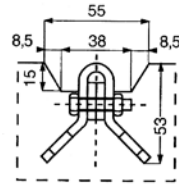

SOLUZIONE
CON BINARIO
SPORGENTE
DAL PAVIMENTO

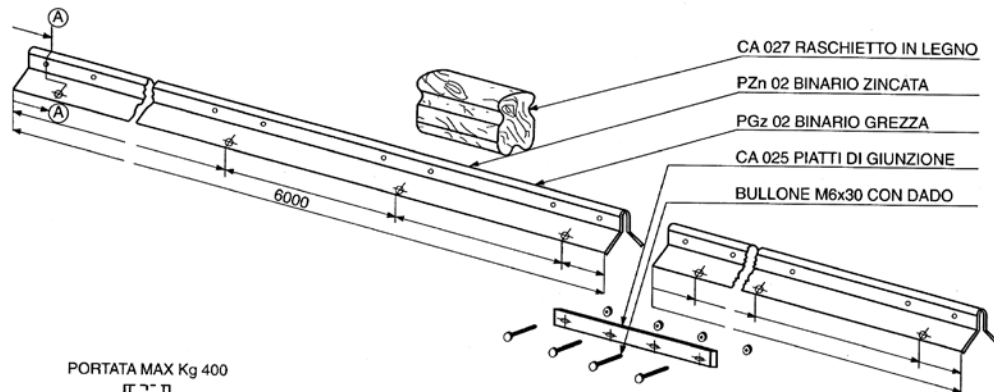
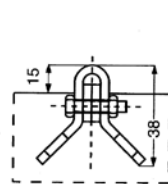

PORTATA MAX Kg 400



PORTATA MAX Kg 250



PORTATA MAX Kg 250



MONOROTAIE

MR 1 "A" (GRANDE)
Tipo per carrelli grandi

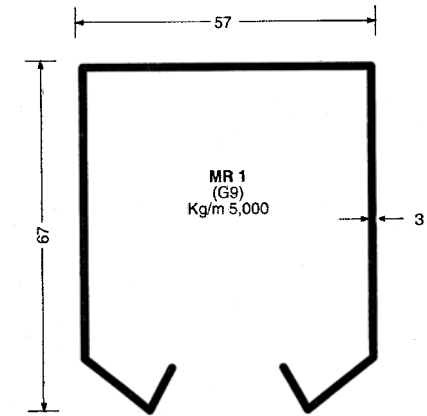

MR 2 "B" (MEDIA)
Tipo per carrelli piccoli

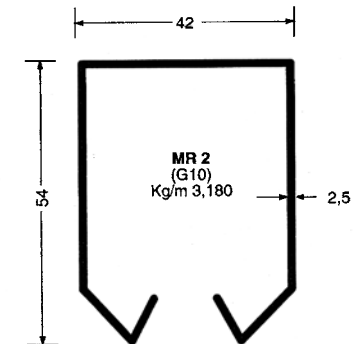

MR 3 "C" (PICCOLA)
Tipo per carrelli mignon

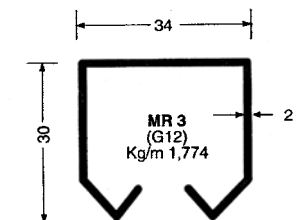

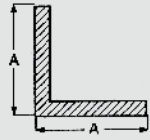

PROFILATI APERTI AD ANGOLO

A x A mm.	SPESSORE mm.	PESO Kg/m.
10 x 10	1,5	0,218
15 x 15	1,5	0,33
	2	0,41
20 x 20	1,5	0,44
	2	0,57
	2,5	0,69
25 x 25	1,5	0,56
	2	0,73
	3	1,05
30 x 30	1,5	0,67
	2	0,88
	3	1,28
35 x 35	2	1,04
	3	1,52
40 x 40	2	1,201
	3	1,75
45 x 45	2	1,35
	3	2,00
50 x 50	2	1,51
	3	2,22
	4	2,90
60 x 60	2,5	2,26
	3	2,69
	4	3,53
70 x 70	3	3,16
	4	4,16
80 x 80	3	3,63
	4	4,78
90 x 90	3	4,10
	4	5,41
100 x 100	3	4,57
	4	6,04
120 x 120	4	7,30
150 x 150	3	3,30
	4	4,40

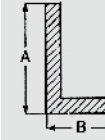

PROFILATI APERTI AD "ELLE"

A x A mm.	SPESSORE mm.	PESO Kg/m.
20 x 10	1,5	0,32
25 x 12	1,5	0,41
	2	0,53
25 x 15	1,5	0,44
	2	0,57
30 x 15	1,5	0,49
	2	0,64
	3	0,94
40 x 15	1,5	0,77
	2	1,03
30 x 20	2	0,73
	3	1,05
40 x 20	2	0,88
	3	1,29
45 x 20	2	0,96
	3	1,41
50 x 20	1,5	0,78
	2	1,04
60 x 20	2	1,20
40 x 25	2	0,96
	3	1,65
50 x 25	2	1,12
	3	1,65
40 x 30	2	1,04
	3	1,53
50 x 30	2	1,20
	3	1,76
60 x 30	2	1,33
	3	2,00
70 x 30	2	1,45
	3	2,17
80 x 30	3	2,47
60 x 40	2	1,48
	3	2,23
80 x 40	2	1,80
	3	2,70
100 x 40	2	2,12
	3	3,17
100 x 50	3	3,37
	4	4,49
150 x 50	3	3,75
120 x 60	3	4,05

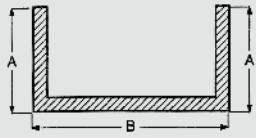

PROFILATI APERTI AD "U"

A x B x A mm.	SPESSORE mm.	PESO Kg/m.
10 x 20 x 10	1,5	0,400
10 x 30 x 10	1,5	0,520
	2	0,660
15 x 30 x 15	1,5	0,635
	2	0,815
20 x 30 x 20	2	0,975
20 x 40 x 20	1,5	0,870
	2	1,130
	3	1,650
20 x 50 x 20	1,5	0,990
	2	1,290
25 x 50 x 25	2	1,445
	3	2,075
30 x 40 x 30	2	1,445
	3	2,075
30 x 50 x 30	2	1,600
	3	2,310
30 x 60 x 30	2	1,760
	3	2,545
40 x 60 x 40	2	2,070
	3	3,015
40 x 80 x 40	2	2,385
	3	3,490
	4	4,525
40 x 100 x 40	2	2,700
	3	3,955
50 x 100 x 50	2	3,015
	3	4,435
	4	5,780
60 x 100 x 60	2	3,330
	3	4,900
60 x 120 x 60	2	3,640
	3	5,370
	4	7,035
60 x 140 x 60	3	5,840
	4	7,660

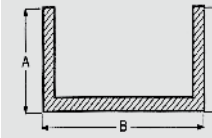

PROFILATI APERTI AD "U"

A x B x A mm.	SPESSORE mm.	PESO Kg/m.
10 x 10 x 10	1,5	0,29
15 x 15 x 15	1,5	0,47
	2	0,59
20 x 20 x 20	1,5	0,65
	2	0,83
25 x 25 x 25	1,5	0,83
	2	1,07
30 x 30 x 30	1,5	1
	2	1,31
	3	1,87
35 x 35 x 35	2	1,55
40 x 40 x 40	2	1,79
	3	2,59
45 x 45 x 45	2	2,07
50 x 50 x 50	2	2,28
	3	3,31
60 x 60 x 60	2	2,76
	3	4,04
	4	5,25

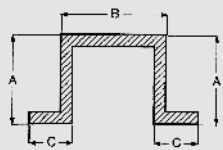

PROFILATI APERTI AD "OMEGA"

C x A x B mm.	SPESSORE mm.	PESO Kg/m.
15 x 20 x 20	1,5	0,94
	2	1,20
15 x 30 x 30	1,5	1,29
	2	1,67
15 x 40 x 40	1,5	1,65
	2	2,14
20 x 50 x 25	1,5	1,70
	2	2,23
20 x 50 x 30	2	2,46
	2,5	3,01
20 x 50 x 40	2	2,62
	2	2,77
20 x 50 x 50	2	2,77
	2,5	3,40
20 x 60 x 30	3	4,01
	2	3,09
25 x 60 x 40	2,5	3,79
	3	4,48
30 x 70 x 50	2	3,71
	3	4,58
25 x 80 x 40	2	3,71
	2,5	4,58
30 x 80 x 40	3	5,42
	2	4,50
30 x 100 x 40	2,5	5,62
	3	6,62
30 x 100 x 50	2	4,70
	2,5	5,80
30 x 100 x 60	3	6,84
	2,5	5,95
40 x 120 x 50	3	7,07
	2,5	6,93
30 x 120 x 60	3	8,24
	2,5	6,74
40 x 120 x 80	3	8,01
	2,5	7,52
45 x 150 x 80	3	8,95
	3,5	10,60
45 x 180 x 80	4	12,28
	3	13,93
45 x 180 x 80	3	11,84
	4	15,53

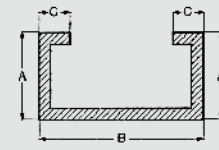

PROFILATI A FREDDO A "C"

C x A x B mm.	SPESSORE mm.	PESO Kg/m.
6 x 20 x 20	1,2	0,60
7,5 x 25 x 25	1,5	0,94
10 x 30 x 30	1,5	1,17
	2	1,52
10 x 20 x 40	1,5	1,04
	2	1,32
15 x 40 x 40	2	2,14
	3	3,06
15 x 30 x 50	1,5	1,53
	2	1,99
20 x 30 x 50	2,5	2,52
	3	3,06
20 x 40 x 50	2,5	3,01
	3	3,53
15 x 50 x 50	3	3,77
	2	2,55
20 x 40 x 60	2	2,58
	3	3,69
20 x 60 x 60	2	3,21
	3	4,63
20 x 40 x 80	2	2,89
	3	4,16
25 x 50 x 100	2	3,68
	3	5,33

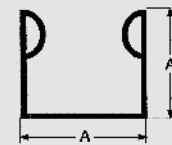

PROFILATI A SCATTO ZINCATI

A x A x A mm.	SPESSORE mm.	PESO Kg/m.
10 x 10 x 10	0,7	0,20
10 x 12 x 12	0,7	0,23