

**TUBI SALDATI**

**A CALDO**

**A FREDDO**

**ZINCATI**

**DECAPATI**

**TUBI  
SALDATI**

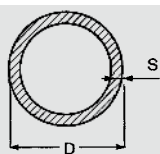

## TUBI TONDI SALDATI RICAVATI DA NASTRO

EN 10219-2/99

D mm	Spessore S/mm							
	1,0	1,2	1,5	2	3	4	5	6
	peso Kg./m							
10	0,22							
12	0,27	0,32						
14	0,32	0,38	0,46					
15	0,37	0,41	0,50					
16	0,37	0,44	0,54	0,69				
18	0,42	0,50	0,61	0,79				
19	0,45	0,53	0,65	0,84				
20	0,47	0,56	0,70	0,91				
22	0,52	0,62	0,77	1,01				
25	0,59	0,70	0,88	1,14				
26	0,62	0,73	0,91	1,18				
28	0,67	0,79	0,98	1,28				
30	0,71	0,85	1,05	1,38	2,00			
32	0,76	0,91	1,13	1,48	2,15			
35	0,83	1,00	1,24	1,63	2,37			
38	0,91	1,09	1,35	1,78	2,59	3,38		
40	0,96	1,15	1,42	1,87	2,74	3,55		
42	1,01	1,21	1,50	1,97	2,88	3,75		
45	1,08	1,30	1,61	2,12	3,11	4,05		
48	1,16	1,38	1,71	2,26	3,30	4,34		
50	1,21	1,45	1,79	2,36	3,48	4,54		
54		1,56	1,94	2,56	3,77	5,03		
57		1,65	2,05	2,70	3,97	5,23		
60		1,74	2,10	2,86	4,22	5,52		
63		1,80	2,26	3,00	4,41	5,82		
70		2,04	2,53	3,35	4,96	6,51	8,02	
76		2,20	2,74	3,63	5,37	7,10	8,76	
80		2,33	2,90	3,85	5,70	7,50	9,26	
89		2,60	3,24	4,27	6,32	8,33	10,36	12,29
102			3,72	4,90	7,32	9,70	11,96	14,37
108			3,94	5,10	7,76	10,20	12,70	15,09
114			4,16	5,58	8,25	10,89	13,44	15,99
121			4,40	5,87	8,65	11,44	14,31	17,02
127					9,12	12,16	15,04	17,90
133					9,62	12,71	15,78	18,79
140					10,15	13,43	16,61	19,78
152					11,05	14,60	18,13	21,60
159					11,55	15,31	18,99	22,64
168					12,22	16,29	20,10	23,97
177,8					12,94	17,16	21,33	25,45
193,7					13,98	18,55	23,06	27,52
219					15,98	21,21	26,39	31,06
244,5						23,75	29,57	35,33
273						26,54	33,05	39,55
323						31,56	39,92	46,30
355,6						34,72	43,28	51,79
406,4						39,74	49,55	59,32

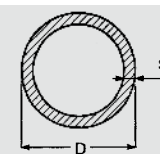

## TUBI TONDI SALDATI RICAVATI DA NASTRO

CARPENTERIA EN10219-1/99

D n	D e	Spessore	Kg./m
3/8"	16,75	1,80	0,66
1/2"	21,25	2,2	1,03
3/4"	26,75	2,5	1,50
1"	33,7	2,65	2,02
1 1/4"	42,4	3	2,91
1 1/2"	48,3	3	3,35
2"	60,3	3	4,24
2 1/2"	76,1	3	5,41
3"	88,9	3	6,36
3 1/2"	101,6	3	7,29
4"	114,3	3	8,23

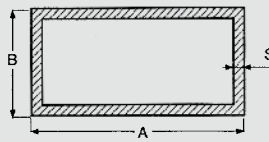

# TUBI RETTANGOLI

EN 10219-2/99

AxB \ S	1,5	2	2,5	3	4	5	6	7	8	9	10
15 x 10	0,47										
20 x 10	0,59	0,74									
20 x 15	0,71	0,89									
25 x 10	0,71	0,89									
25 x 15	0,83	1,05	1,25	1,42							
25 x 20	0,94	1,21	1,44	1,65							
30 x 10	0,83	1,05									
30 x 15	0,98	1,28	1,56	1,85							
30 x 20	1,06	1,36	1,64	1,89							
30 x 25	1,18	1,52	1,84	2,13							
35 x 10	0,94	1,21									
35 x 15	1,06	1,36	1,64	1,89							
35 x 20	1,18	1,52	1,84	2,13							
40 x 10	1,06	1,36									
40 x 15	1,18	1,52	1,84	2,13							
40 x 20	1,30	1,68	2,03	2,36							
40 x 25	1,41	1,83	2,23	2,60							
40 x 30	1,53	1,99	2,42	2,83	3,57						
45 x 20	1,41	1,83	2,23	2,60							
50 x 10	1,30	1,68									
50 x 15	1,41	1,83									
50 x 20	1,53	1,99	2,42	2,83							
50 x 25	1,65	2,15	2,62	3,07							
50 x 30	1,77	2,31	2,82	3,30	4,20						
50 x 40	2,00	2,62	3,21	3,77	4,83						
60 x 10	1,53	1,99									
60 x 15	1,65	2,15									
60 x 20	1,77	2,31	2,82	3,30							
60 x 25	1,89	2,46	3,01	3,54							
60 x 30	2,00	2,62	3,21	3,77	4,83						
60 x 40	2,24	2,93	3,60	4,25	5,45	6,39					
60 x 50	2,47	3,25	3,99	4,72	6,08	7,18					
70 x 20	2,00	2,62	3,21	3,77							
70 x 25	2,12	2,78	3,41	4,01							
70 x 30	2,24	2,93	3,60	4,25	5,45						
70 x 35	2,36	3,09	3,80	4,48	5,77						
70 x 40	2,47	3,25	3,99	4,72	6,08	7,18					
70 x 50	2,71	3,56	4,39	5,19	6,71	7,96	9,20				
80 x 15	2,12	2,78	3,41	4,01							
80 x 20	2,24	2,93	3,60	4,25							
80 x 25	2,36	3,09	3,80	4,48							
80 x 30	2,47	3,25	3,99	4,72	6,08						
80 x 40	2,71	3,56	4,39	5,19	6,71	7,96	9,20				

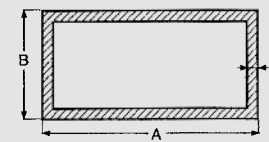

# TUBI RETTANGOLI

EN 10219-2/99

AxB \ S	1,5	2	2,5	3	4	5	6	7	8	9	10
80 x 50		3,88	4,78	5,66	7,34						
80 x 60		4,19	5,17	6,13	7,97	9,53	11,09	12,53			
90 x 20	2,47	3,25	3,99	4,72							
90 x 30	2,71	3,56	4,39	5,19	6,71						
90 x 40		3,88	4,78	5,66	7,34						
90 x 50		4,19	5,17	6,13	7,97						
90 x 60		4,50	5,56	6,60	8,59						
100 x 20	2,71	3,56	4,39	5,19							
100 x 30		3,88	4,78	5,66	7,34						
100 x 40		4,19	5,17	6,13	7,97	9,53	11,09				
100 x 50		4,50	5,56	6,60	8,59	10,32	12,03	16,63			
100 x 60		4,82	5,96	7,07	9,22	11,10	12,97	14,72			
100 x 70		5,13	6,35	7,54	9,85	11,89	13,91				
100 x 80		5,45	6,74	8,01	10,48	12,67	14,86	16,92			
110 x 50		4,82	5,96	7,07	9,22	11,10	12,97	14,72			
120 x 30		4,50	5,56	6,60	8,59						
120 x 40		4,82	5,96	7,07	9,22	11,10	12,97	14,72			
120 x 60		5,45	6,74	8,01	10,48	12,67	14,86	16,92			
120 x 80		6,07	7,53	8,96	11,73	14,24	16,74	19,12	21,39		
120 x 100			8,31	9,90	12,99	15,81	18,62	21,32			
130 x 50		5,45	6,74	8,01	10,48	12,67	14,86				
140 x 40		5,45	6,74	8,01	10,48	12,67	14,86				
140 x 60		6,07	7,35	8,96	11,73	14,24	16,74	19,12			
140 x 70				9,43	12,36	15,03	17,68	20,22			
140 x 80			8,31	9,90	12,99	15,81	18,62	21,32			
150 x 30		5,45	6,74	8,01	10,48						
150 x 40		5,87	7,31	8,73	11,54	14,31	17,02				
150 x 50		6,07	7,53	8,96	11,73	14,24	16,74	19,12			
150 x 100				11,31	14,87	18,17	21,45	24,62			
160 x 40		6,07	7,53	8,96	11,73	14,24	16,74				
160 x 50				9,43	12,36	15,03	17,68				
160 x 80				10,84	14,25	17,38	20,51	23,52	26,41		
180 x 40				9,90	12,89	15,81	18,62				
180 x 60				10,84	14,25	17,38	20,51	23,52			
180 x 80				11,78	15,50	18,95	22,39	25,71	28,92		
200 x 100				13,67	18,01	22,09	26,16	30,11	33,95	37,12	41,59
200 x 150				16,02	21,15	26,02	30,87	35,61	40,23	44,18	48,44
250 x 100				16,02	21,15	26,02	30,87	35,61	40,23	44,18	48,44
250 x 150					24,29	29,94	35,58	41,10	46,51	51,25	56,29
300 x 100					24,29	29,94	35,58	41,10	46,51		
300 x 150					27,43	33,87	40,29	46,60	52,79		
300 x 200					30,57	37,79	45,00	52,09	59,07		
400 x 200						45,64	54,42	63,08	71,63		
400 x 250						49,57	59,13	68,58	77,91		

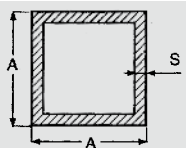

## TUBI QUADRI

EN 10219-2/99

AxA \ S	1,5	2	2,5	3	4	5	6	7	8	9	10
10 x 10	0,35										
12 x 12	0,57										
15 x 15	0,59	0,74									
18 x 18	0,73	0,92									
20 x 20	0,83	1,05	1,25	1,42							
25 x 25	1,06	1,36	1,64	1,89							
30 x 30	1,30	1,68	2,03	2,36	2,94						
35 x 35	1,53	1,99	2,42	2,83	3,57						
40 x 40	1,77	2,31	2,82	3,30	4,20	4,82					
45 x 45	2,00	2,62	3,21	3,77	4,83	5,61					
50 x 50	2,24	3,01	3,60	4,25	5,45	6,39					
60 x 60	2,71	3,56	4,39	5,19	6,71	7,96	9,20				
65 x 65		3,88	4,78	5,66	7,34						
70 x 70		4,19	5,17	6,13	7,97	9,53	11,09	12,53			
80 x 80		4,82	5,96	7,07	9,22	11,10	12,97	14,72	16,36		
90 x 90		5,45	6,74	8,01	10,48	12,67	14,86	16,92			
100 x 100		6,07	7,53	8,96	11,73	14,24	16,74	19,12	21,39	22,99	24,89
110 x 110				9,90	12,99	15,81	18,62	21,32	23,90	25,81	28,03
120 x 120				10,84	14,25	17,38	20,51	23,52	26,41	28,64	31,17
140 x 140				12,72	16,76	20,52	24,28	27,91	31,43	34,29	37,45
150 x 150				13,67	18,01	22,09	26,16	30,11	33,95	37,12	40,59
160 x 160				14,61	19,27	23,66	28,04	32,31	36,46	39,94	43,73
175 x 175				16,02	21,15	26,02	30,87	35,61	40,23	44,18	48,44
180 x 180					21,78	26,80	31,81	36,70	41,48	45,60	50,01
200 x 200					24,29	29,94	35,58	41,10	46,51	51,25	56,29
220 x 220					26,81	33,08	39,35	45,50	51,53	56,60	62,57
250 x 250					30,57	37,79	45,00	52,09	59,07	65,38	71,99
260 x 260					31,83	39,36	46,88	54,29	61,58	68,20	75,13
300 x 300						45,64	54,42	63,08	71,63	79,51	87,69
325 x 325						49,57	59,13	68,58	77,91	86,57	95,54

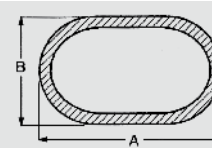

## TUBI A SEZIONI VARIE

OVALE

AxB \ S	30	36	40	50	60	31	45	50	60	80
S	15	18	20	25	30	16	20	10	20	45
1,5	0,86	1,05	1,12	1,50	1,87	0,90	1,32	1,29	1,63	
2,0	1,13	1,38	1,47	1,95	2,47	1,19			2,16	
3				2,86	3,63					
4										6,68

### ELLITTICO

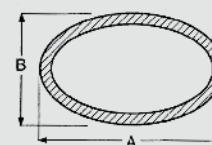

AxB \ S	30	40
S	15	20
1,5	0,83	1,09
2	1,08	1,42

### ROMBOIDE

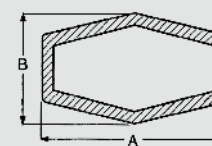

AxB \ S	40
S	20
1,5	1,23
2	1,62

### TRIANGOLO

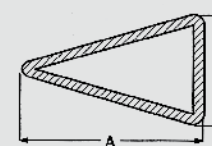

AxB \ S	30	40	60	60
S	15	22	38	55
1,5	0,86	1,24		
2	1,13	1,63		
3			3,73	4,29

### SEMIOVALE

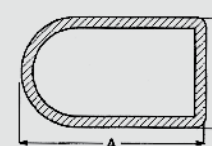

AxB \ S	30	40	102	80
S	15	20	32	40
1,5	0,97	1,23		2,59
2	1,27	1,62	4,06	

# TUBI PER SERRAMENTI SPESSORE mm. 1,5

RICAVATI DA NASTRO DECAPATO E/O ZINCATO

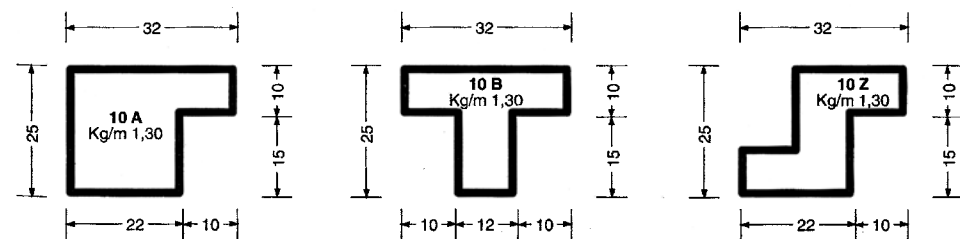
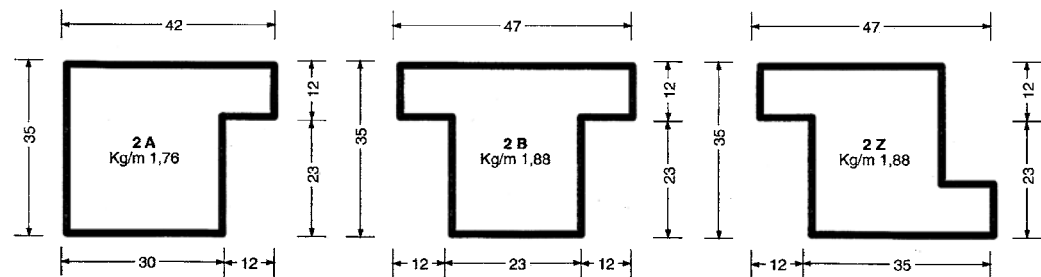
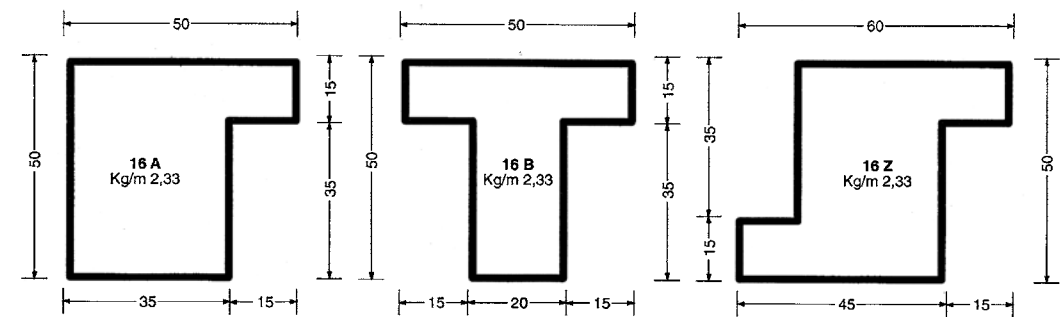
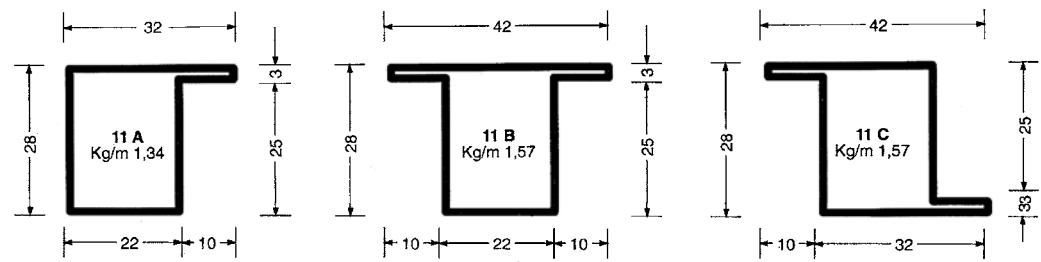
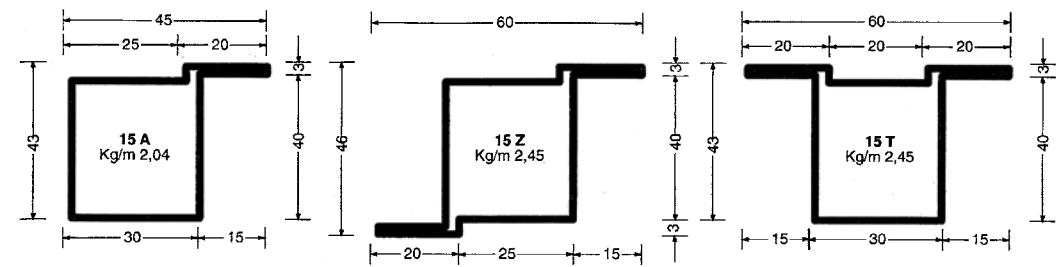
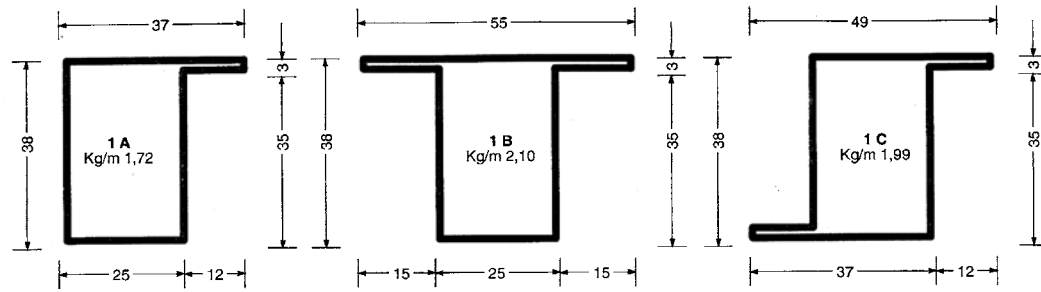

## TUBI PER SERRAMENTI SPESSORE mm. 1,5 - 2,0

RICAVATI DA NASTRO DECAPATO E/O ZINCATO

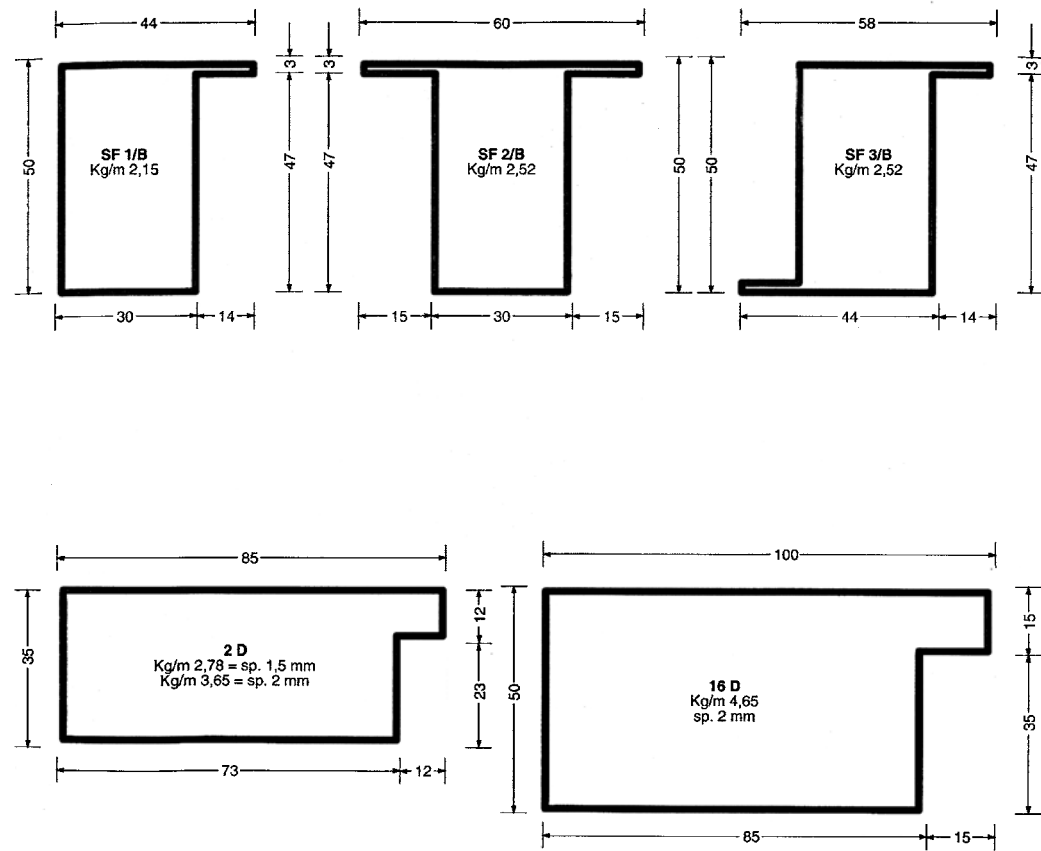

## TUBI PER MANCORRENTI SPESSORE mm. 1,5

RICAVATI DA NASTRO DECAPATO E/O ZINCATO

